



# NPN SILICON GERMANIUM RF TRANSISTOR

# NESG260234

## NPN SiGe RF TRANSISTOR FOR MEDIUM OUTPUT POWER AMPLIFICATION (1 W) 3-PIN POWER MINIMOLD (34 PKG)

### FEATURES

- This product is suitable for medium output power (1 W) amplification
  - $P_{out} = 30$  dBm TYP. @  $V_{CE} = 6$  V,  $P_{in} = 15$  dBm,  $f = 460$  MHz
  - $P_{out} = 30$  dBm TYP. @  $V_{CE} = 6$  V,  $P_{in} = 20$  dBm,  $f = 900$  MHz
- MSG (Maximum Stable Gain) = 23 dB TYP. @  $V_{CE} = 6$  V,  $I_c = 100$  mA,  $f = 460$  MHz
- Using UHS2-HV process (SiGe technology),  $V_{CBO}$  (ABSOLUTE MAXIMUM RATINGS) = 25 V
- 3-pin power minimold (34 PKG)

### ORDERING INFORMATION

Part Number	Order Number	Package	Quantity	Supplying Form
NESG260234	NESG260234-AZ	3-pin power minimold (Pb-Free) <sup>Note1, 2</sup>	25 pcs (Non reel)	• Magazine case
NESG260234-T1	NESG260234-T1-AZ		1 kpcs/reel	• 12 mm wide embossed taping • Pin 2 (Emitter) face the perforation side of the tape

**Notes 1.** Contains Lead in the part except the electrode terminals.

**2.** With regards to terminal solder (the solder contains lead) plated products (conventionally plated), contact your nearby sales office.

**Remark** To order evaluation samples, contact your nearby sales office.

Unit sample quantity is 25 pcs.

### ABSOLUTE MAXIMUM RATINGS ( $T_A = +25^\circ\text{C}$ )

Parameter	Symbol	Ratings	Unit
Collector to Base Voltage	$V_{CBO}$	25	V
Collector to Emitter Voltage	$V_{CEO}$	9.2	V
Emitter to Base Voltage	$V_{EBO}$	2.8	V
Collector Current	$I_c$	600	mA
Total Power Dissipation	$P_{tot}$ <sup>Note</sup>	1.9	W
Junction Temperature	$T_j$	150	$^\circ\text{C}$
Storage Temperature	$T_{stg}$	-65 to +150	$^\circ\text{C}$

**Note** Mounted on  $34.2 \text{ cm}^2 \times 0.8 \text{ mm}$  (t) glass epoxy PWB

**Caution** Observe precautions when handling because these devices are sensitive to electrostatic discharge.

The information in this document is subject to change without notice. Before using this document, please confirm that this is the latest version.

**THERMAL RESISTANCE (T<sub>A</sub> = +25°C)**

Parameter	Symbol	Ratings	Unit
Thermal Resistance from Junction to Ambient <sup>Note</sup>	R <sub>thj-a</sub>	65	°C/W

**Note** Mounted on 34.2 cm<sup>2</sup> × 0.8 mm (t) glass epoxy PWB

**RECOMMENDED OPERATING RANGE (T<sub>A</sub> = +25°C)**

Parameter	Symbol	MIN.	TYP.	MAX.	Unit
Collector to Emitter Voltage	V <sub>CE</sub>	–	6.0	7.2	V
Collector Current	I <sub>c</sub>	–	400	500	mA
Input Power <sup>Note</sup>	P <sub>in</sub>	–	15	20	dBm

**Note** Input power under conditions of V<sub>CE</sub> ≤ 6.0 V, f = 460 MHz

**ELECTRICAL CHARACTERISTICS (T<sub>A</sub> = +25°C)**

Parameter	Symbol	Test Conditions	MIN.	TYP.	MAX.	Unit
<b>DC Characteristics</b>						
Collector Cut-off Current	I <sub>CBO</sub>	V <sub>CB</sub> = 9.2 V, I <sub>E</sub> = 0 mA	–	–	1	μA
Emitter Cut-off Current	I <sub>EBO</sub>	V <sub>EB</sub> = 1.0 V, I <sub>C</sub> = 0 mA	–	–	1	μA
DC Current Gain	h <sub>FE</sub> <sup>Note</sup>	V <sub>CE</sub> = 3 V, I <sub>C</sub> = 100 mA	80	120	180	–
<b>RF Characteristics</b>						
Linner Gain (1)	G <sub>L</sub>	V <sub>CE</sub> = 6 V, I <sub>C (set)</sub> = 30 mA (RF OFF), f = 460 MHz, P <sub>in</sub> = 0 dBm	19	22	–	dB
Linner Gain (2)	G <sub>L</sub>	V <sub>CE</sub> = 6 V, I <sub>C (set)</sub> = 30 mA (RF OFF), f = 900 MHz, P <sub>in</sub> = 0 dBm	–	19	–	dB
Output Power (1)	P <sub>out</sub>	V <sub>CE</sub> = 6 V, I <sub>C (set)</sub> = 30 mA (RF OFF), f = 460 MHz, P <sub>in</sub> = 15 dBm	28.5	30.0	–	dBm
Output Power (2)	P <sub>out</sub>	V <sub>CE</sub> = 6 V, I <sub>C (set)</sub> = 30 mA (RF OFF), f = 900 MHz, P <sub>in</sub> = 20 dBm	–	30.0	–	dBm
Collector Efficiency (1)	η <sub>C</sub>	V <sub>CE</sub> = 6 V, I <sub>C (set)</sub> = 30 mA (RF OFF), f = 460 MHz, P <sub>in</sub> = 15 dBm	–	50	–	%
Collector Efficiency (2)	η <sub>C</sub>	V <sub>CE</sub> = 6 V, I <sub>C (set)</sub> = 30 mA (RF OFF), f = 900 MHz, P <sub>in</sub> = 20 dBm	–	60	–	%

**Note** Pulse measurement: PW ≤ 350 μs, Duty Cycle ≤ 2%

**h<sub>FE</sub> CLASSIFICATION**

Rank	FB
Marking	SP
h <sub>FE</sub> Value	80 to 180

★ TYPICAL CHARACTERISTICS ( $T_A = +25^\circ\text{C}$ , unless otherwise specified)

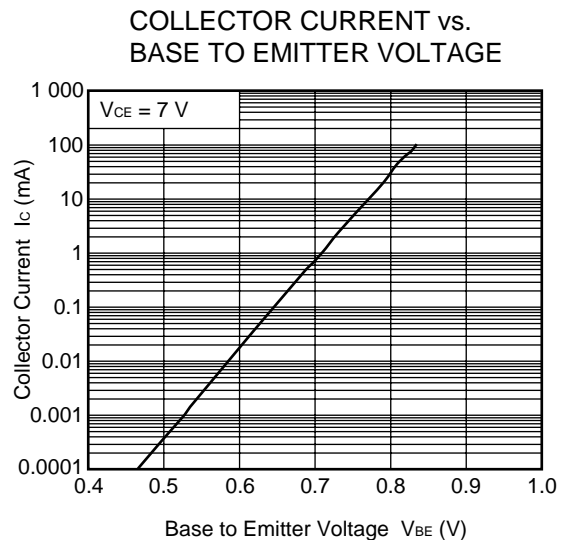
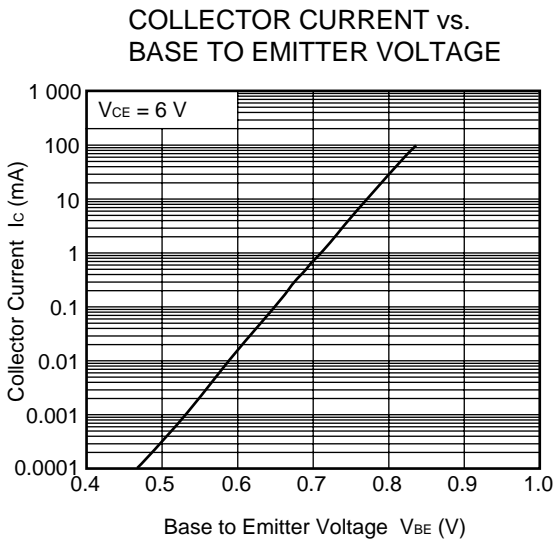
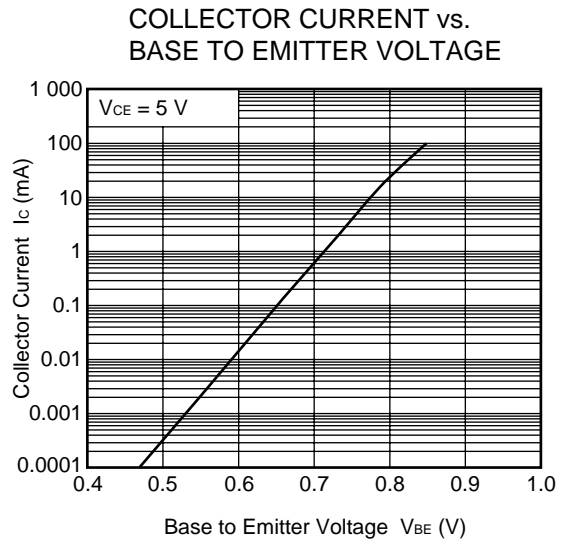
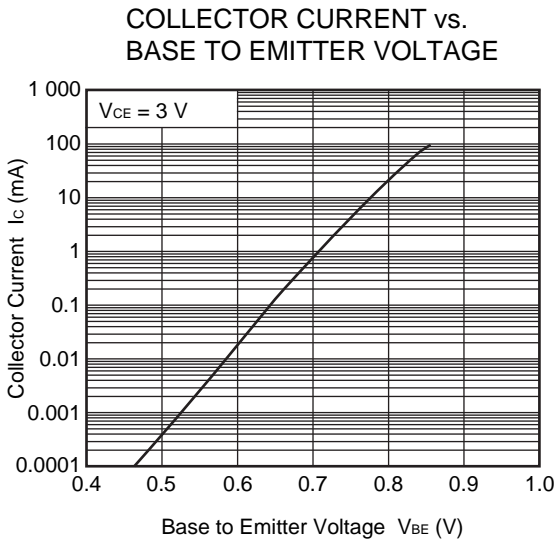
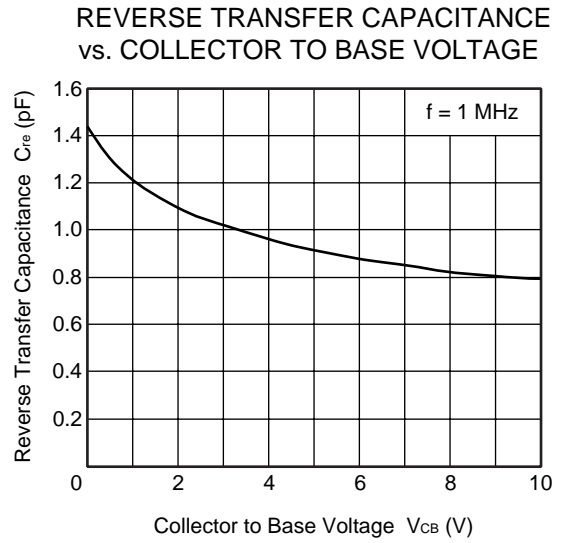
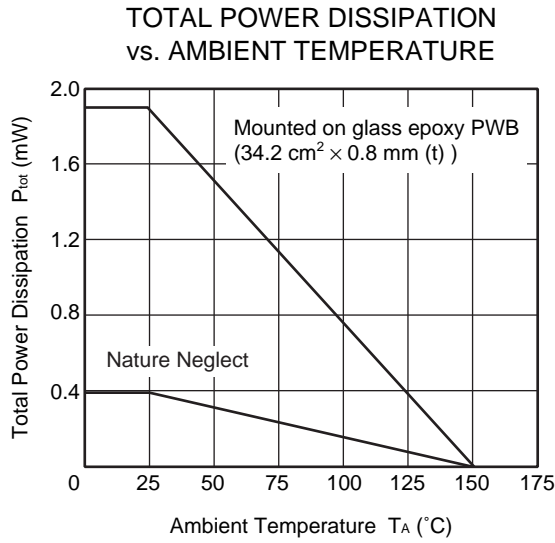

**Remark** The graphs indicate nominal characteristics.

COLLECTOR CURRENT vs. COLLECTOR TO EMITTER VOLTAGE

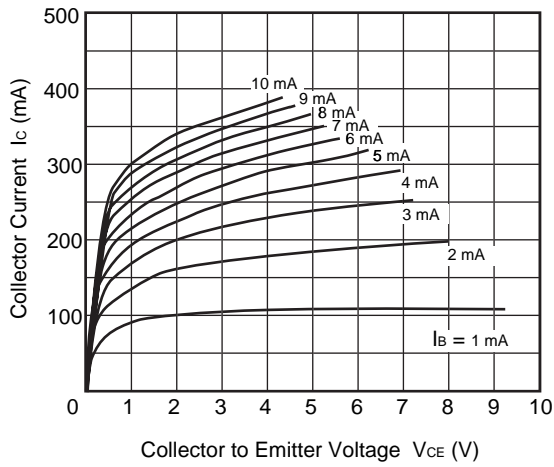

DC CURRENT GAIN vs. COLLECTOR CURRENT

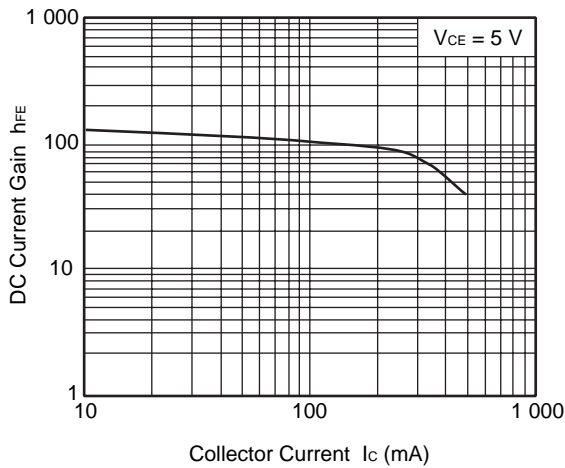

DC CURRENT GAIN vs. COLLECTOR CURRENT

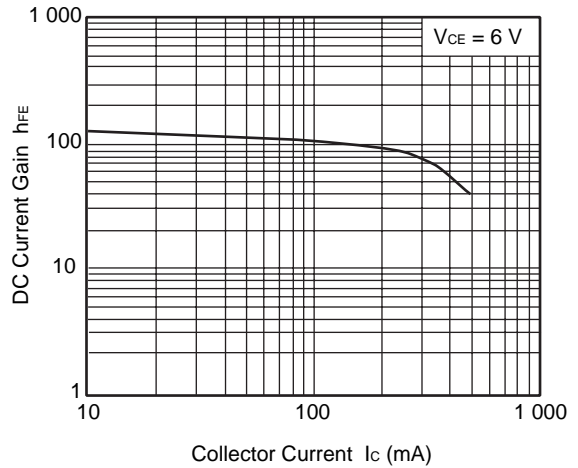

DC CURRENT GAIN vs. COLLECTOR CURRENT

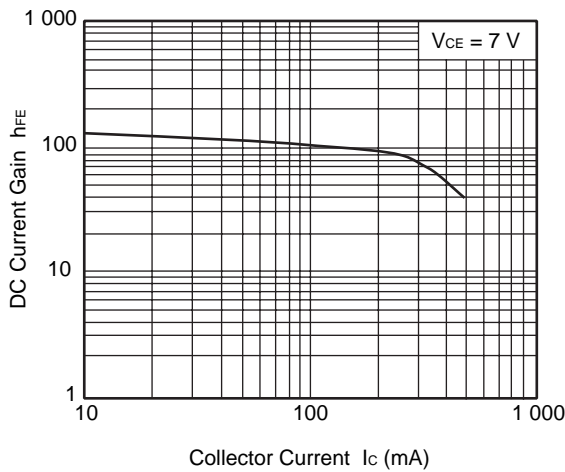

GAIN BANDWIDTH PRODUCT vs. COLLECTOR CURRENT

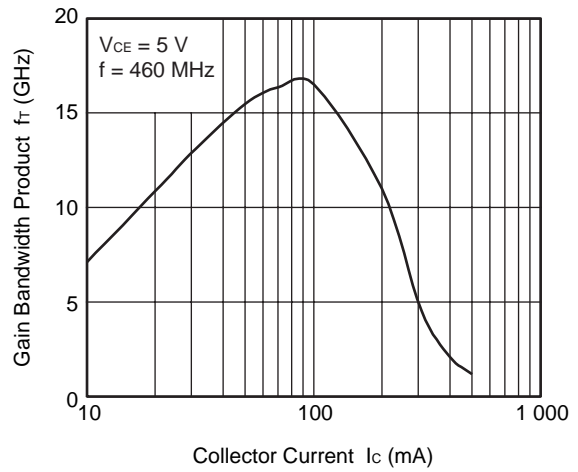

**Remark** The graphs indicate nominal characteristics.

GAIN BANDWIDTH PRODUCT vs. COLLECTOR CURRENT

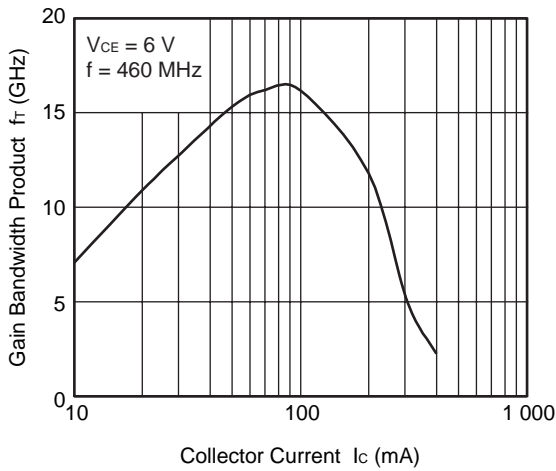

GAIN BANDWIDTH PRODUCT vs. COLLECTOR CURRENT

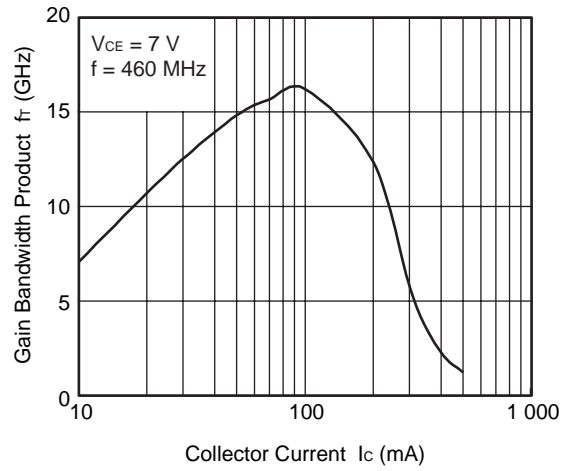

INSERTION POWER GAIN, MAG, MSG vs. FREQUENCY

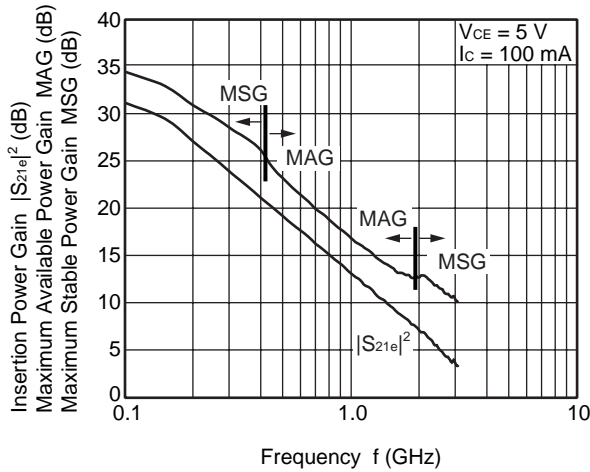

INSERTION POWER GAIN, MAG, MSG vs. FREQUENCY

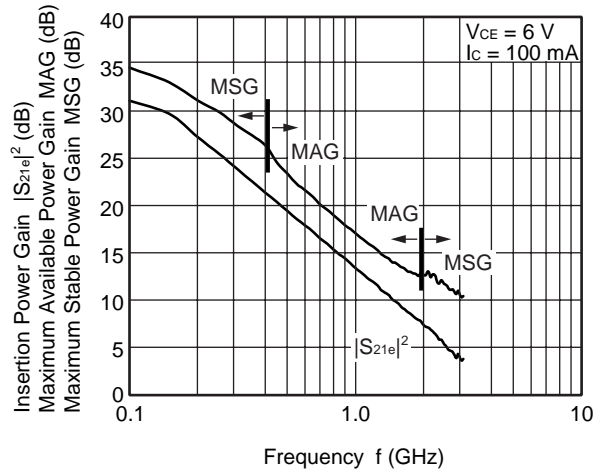

INSERTION POWER GAIN, MAG, MSG vs. FREQUENCY

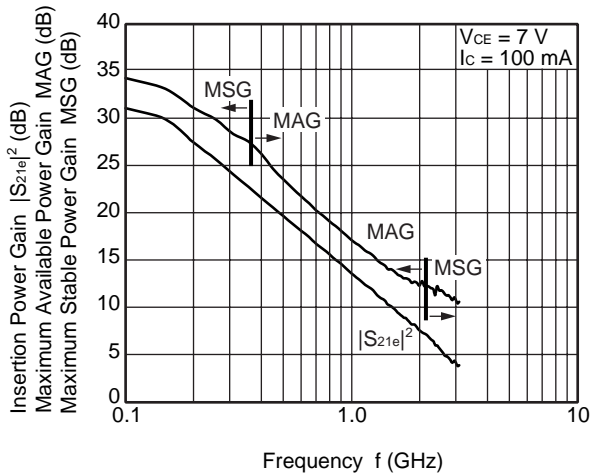

INSERTION POWER GAIN, MAG, MSG vs. COLLECTOR CURRENT

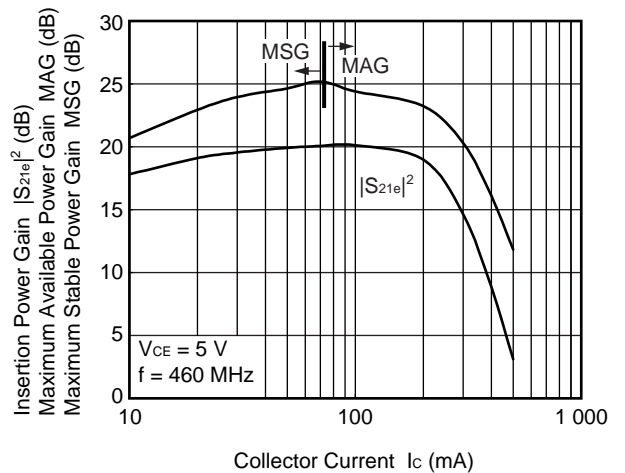

**Remark** The graphs indicate nominal characteristics.

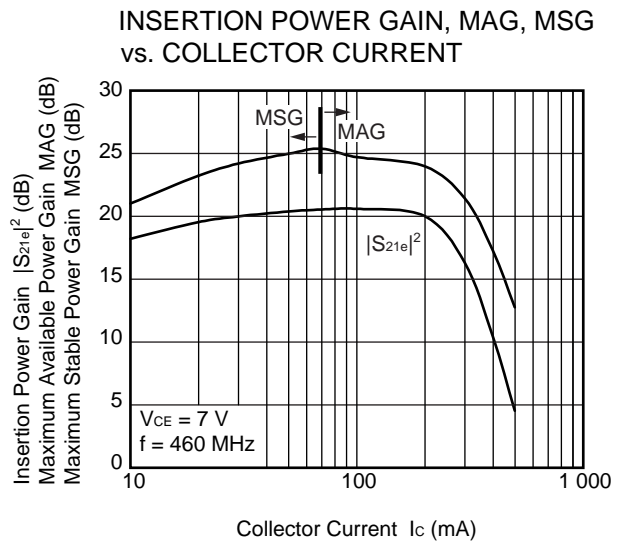
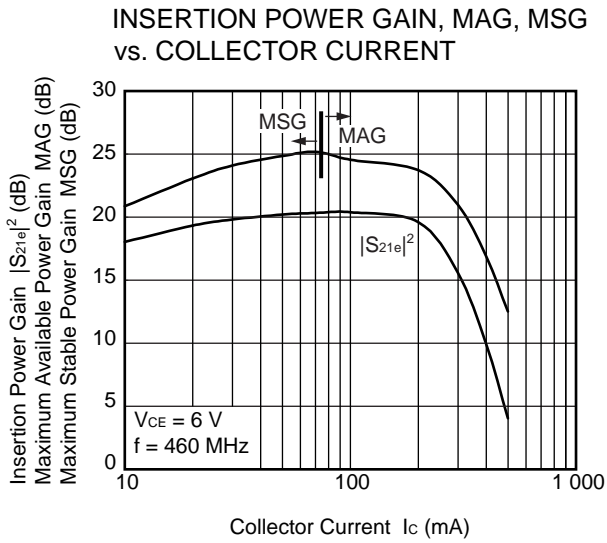

★ **S-PARAMETERS**

S-parameters/Noise parameters are provided on the NEC Compound Semiconductor Devices Web site in a form (S2P) that enables direct import to a microwave circuit simulator without keyboard input.

Click here to download S-parameters.

[RF and Microwave] → [Device Parameters]

URL <http://www.ncsd.necel.com/>

★ **PA EVALUATION CIRCUIT TYPICAL CHARACTERISTICS**

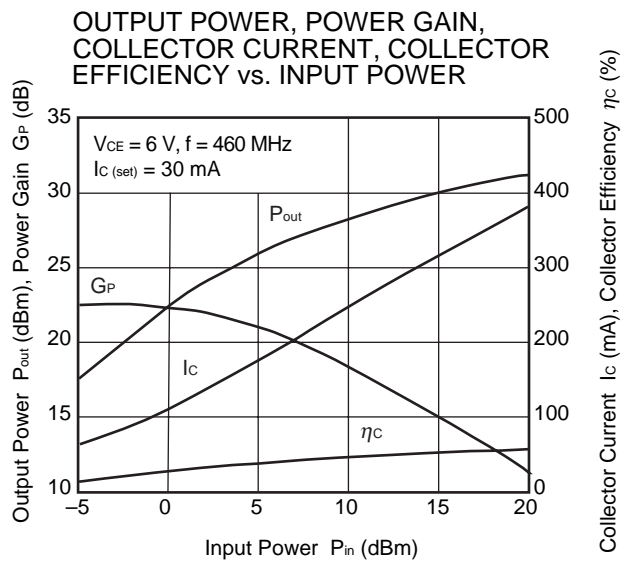
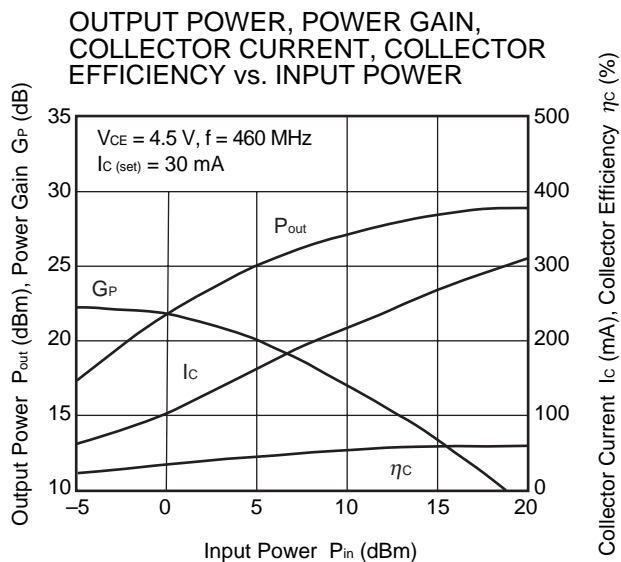

**Remark** The graphs indicate nominal characteristics.

★ EVALUATION CIRCUIT (f = 460 MHz)

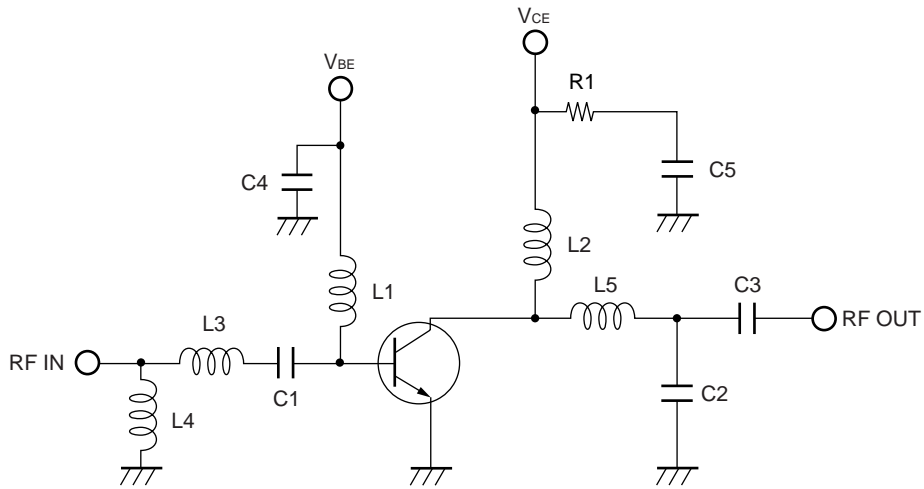

The application circuits and their parameters are for reference only and are not intended for use in actual design-ins.

★ EVALUATION BOARD (f = 460 MHz)

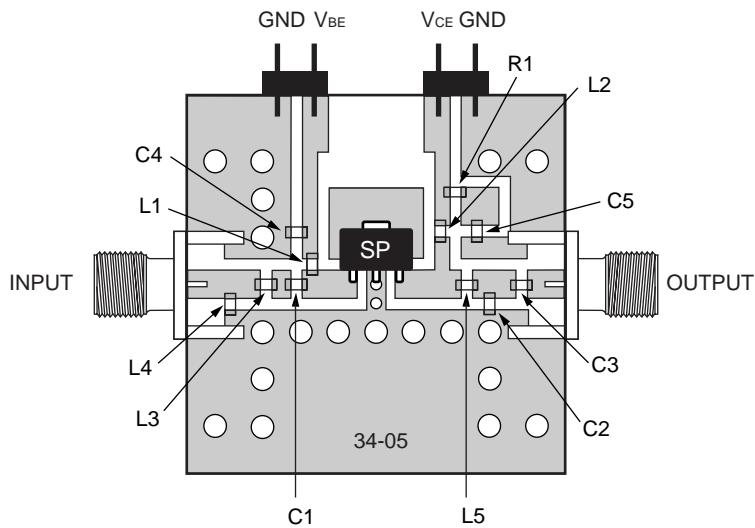

**Notes**

1. 20 × 20 mm, t = 0.8 mm double sided copper clad glass epoxy PWB.
2. Back side: GND pattern
3. Solder gold plated on pattern
4. ○: Through holes



★ **COMPONENT LIST**

Component	Maker	Value	Size (TYPE)	Purpose
C1	Murata	10 pF	1005	Input DC Block/Input RF Matching
C2	Murata	4 pF	1005	Input RF Matching
C3	Murata	33 pF	1005	Input DC Block/Output RF Matching
C4	Murata	10 000 pF	1005	RF GND
C5	Murata	1 $\mu$ F	1608	RF GND
L1	Toko	68 nH	1005	RF Block/Input RF Matching
L2	Toko	33 nH	LLQ2021	RF Block/Output RF Matching
L3	Toko	1 nH	1005	Input RF Matching
L4	Toko	8.2 nH	1005	Input RF Matching
L5	Toko	8.2 nH	LLQ2021	Output RF Matching
R1	SSM	15 $\Omega$	1608	Improve Stability

**PACKAGE DIMENSIONS**

**3-PIN POWER MINIMOLD (34 PKG) (UNIT: mm)**

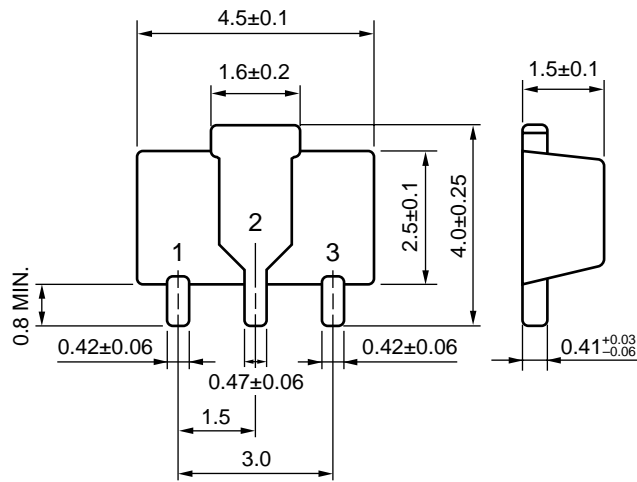

**PIN CONNECTIONS**

- 1. Collector
- 2. Emitter
- 3. Base

Subject: Compliance with EU Directives

CEL certifies, to its knowledge, that semiconductor and laser products detailed below are compliant with the requirements of European Union (EU) Directive 2002/95/EC Restriction on Use of Hazardous Substances in electrical and electronic equipment (RoHS) and the requirements of EU Directive 2003/11/EC Restriction on Penta and Octa BDE.

CEL Pb-free products have the same base part number with a suffix added. The suffix –A indicates that the device is Pb-free. The –AZ suffix is used to designate devices containing Pb which are exempted from the requirement of RoHS directive (\*). In all cases the devices have Pb-free terminals. All devices with these suffixes meet the requirements of the RoHS directive.

This status is based on CEL’s understanding of the EU Directives and knowledge of the materials that go into its products as of the date of disclosure of this information.

Restricted Substance per RoHS	Concentration Limit per RoHS (values are not yet fixed)	Concentration contained in CEL devices	
		-A	-AZ
Lead (Pb)	< 1000 PPM	Not Detected	(*)
Mercury	< 1000 PPM	Not Detected	
Cadmium	< 100 PPM	Not Detected	
Hexavalent Chromium	< 1000 PPM	Not Detected	
PBB	< 1000 PPM	Not Detected	
PBDE	< 1000 PPM	Not Detected	

If you should have any additional questions regarding our devices and compliance to environmental standards, please do not hesitate to contact your local representative.

Important Information and Disclaimer: Information provided by CEL on its website or in other communications concerning the substance content of its products represents knowledge and belief as of the date that it is provided. CEL bases its knowledge and belief on information provided by third parties and makes no representation or warranty as to the accuracy of such information. Efforts are underway to better integrate information from third parties. CEL has taken and continues to take reasonable steps to provide representative and accurate information but may not have conducted destructive testing or chemical analysis on incoming materials and chemicals. CEL and CEL suppliers consider certain information to be proprietary, and thus CAS numbers and other limited information may not be available for release.

In no event shall CEL’s liability arising out of such information exceed the total purchase price of the CEL part(s) at issue sold by CEL to customer on an annual basis.

See CEL Terms and Conditions for additional clarification of warranties and liability.